

Module 6B: Creating Poly-Conic Sheet Metal Pieces for a Spherical Space

In Module 6B, we will learn how to create a folded 3D model of an approximate 2D flat pattern for a 120-inch or 10-foot diameter semi-spherical dome of an astronomy observatory, by the poly-conic method (also called the “zone” method), which consists of cutting the surface of the semi-sphere into segments of conical surfaces, normally from top to bottom, in a North-South direction, or along the longitudinal lines. In this case, the double-curved semi-spherical surface of the dome will be substituted by 6 single-curved conical surface stripes (1 regular cone plus 5 frustums of cone); and because the conical stripes at the bottom are to long as to fit into available material sizes, they will be cut into several segments in turn.

Step 1: Creating a generic Cone Profile Sketch file and Save A Copy As several Sheet Metal (in).ipt part files for poly-conical parts

Launch Inventor, start a new **Sheet Metal (in).ipt** file under the **English** tab. Turn **Visibility** on for the **XY Plane**. “*Sketch1*” is created by default on the **XY Plane** (the one parallel to your computer’s screen); rename *Sketch1* as *Cone Profile Sketch* in the **Model** pane; use the **Project Geometry** tool to project the **Center Point** onto the sketch for a snap point; use the **Circle Center Point** and **General Dimension** tools to draw a 120-inch circle snapped-centered at the projected **Center Point** (*Figure 6B-8A*); change the line **Style** of the circle to **Construction** (*Figure 6B-8B*); use the **Line** tool to draw a vertical line starting at the projected **Center Point** and extending upward; use the **Trim** tool to trim it against the top quadrant point of the circle; the trimmed vertical line will be used as an axis of revolution for the **Revolve** features of the conical stripes that will be created later; next, use the **Polygon** tool with **Inscribed** option to draw a 24-sided polygon centered at the projected **Center Point**, with the corner point snapped to the endpoint of the vertical line (*Figure 6B-8C* and *Figure 6B-8D*); next, delete three quadrants of the polygon with the **Delete** key on the keyboard; and use the **Offset** and **General Dimension** tools to offset the remaining top-right quadrant of the polygon outward by 0.24-inch (*Figure 6B-8E*), the thickness of the sheet metal material, which is pretty thick! Next, use the **Zoom Window** tool to zoom in each side of the polygon, and use the **Line** tool to add short line segments starting at the corner points of the inner polygon and perpendicular to the outer polygon, with the help of **Perpendicularity** constraint indicator, which appears on the screen when the cursor is moved closer to an

existing line after the starting point of a new line has been clicked; and use the **Trim** tool to trim off unneeded segments (*Figure 6B-8F*).

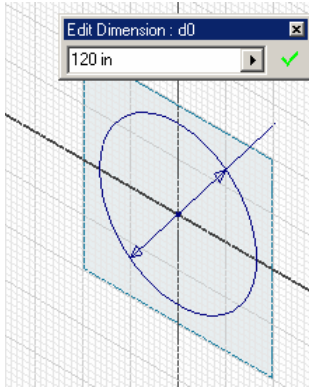

Figure 6B-8A:
drawing the 24-inch
diameter circle.

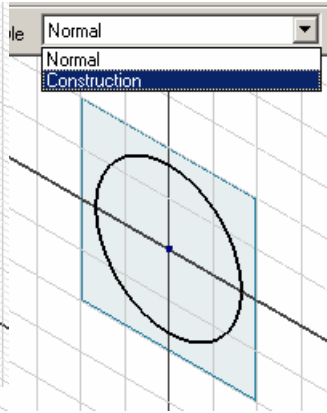

Figure 6B-8B: Changing
the line **Style** of the circle.

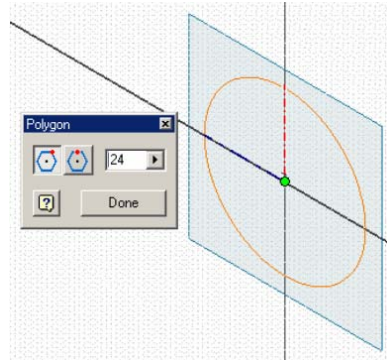

Figure 6B-8C: Drawing the
centerline; and picking the
center of the polygon

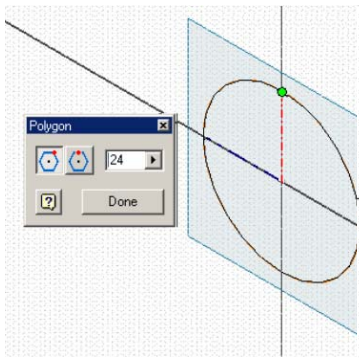

Figure 6B-8D: The
corner point of the 24-
inch inscribed polygon.

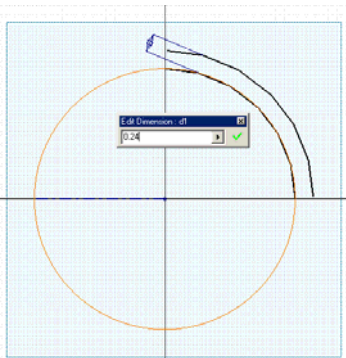

Figure 6B-8E: Deleting
three quadrants of the
polygon and applying the
0.24-inch offset for
thickness.

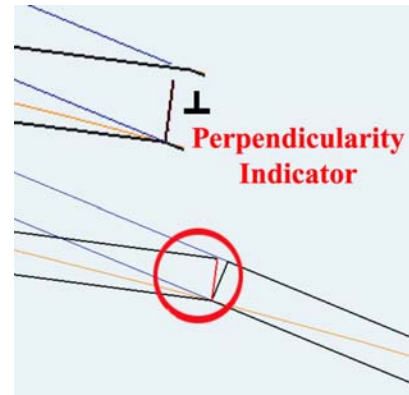

Figure 6B-8F: The
Perpendicular line segments
and the **Perpendicularity**
constraint indicator.

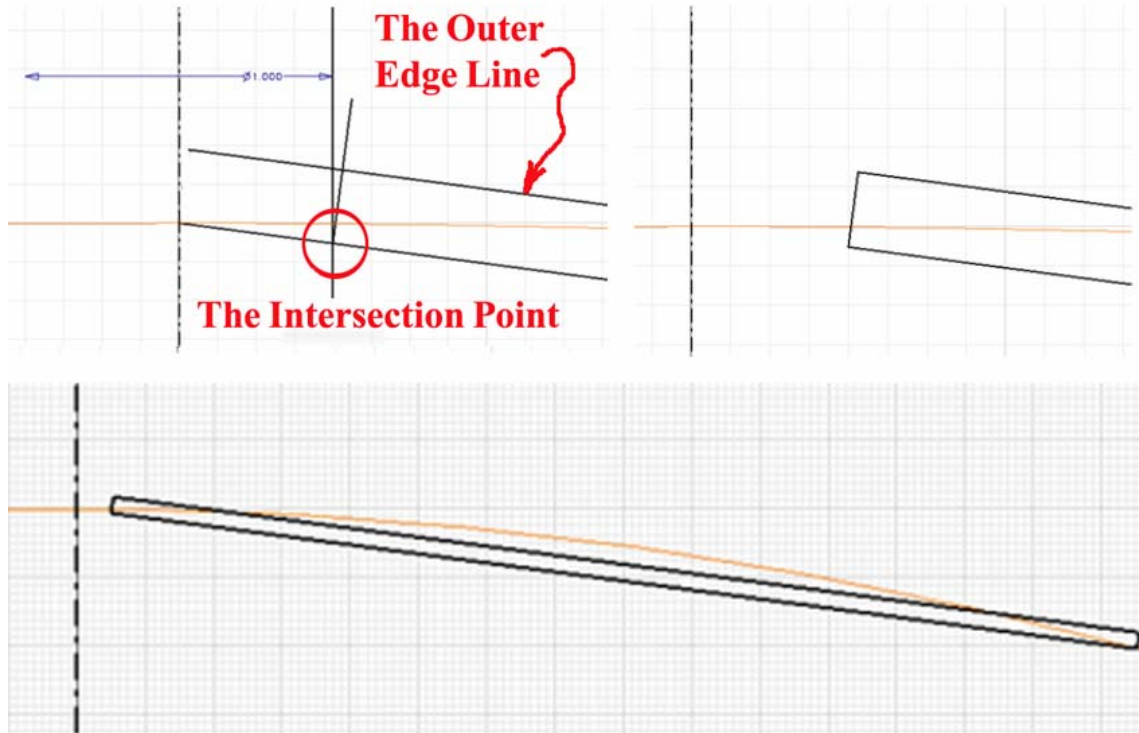

Figure 6B-8G: Portion of the Cone Profile Sketch close to the vertex point with added “vertex relief” opening. Construction of the profile’s top conical section (top left); complete corner (top right); and the entire top cone profile (bottom).

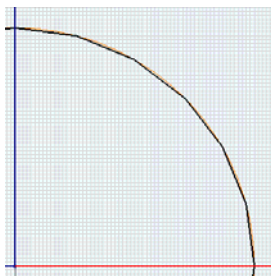

Figure 6B-8H: The initial Cone Profile Sketch.

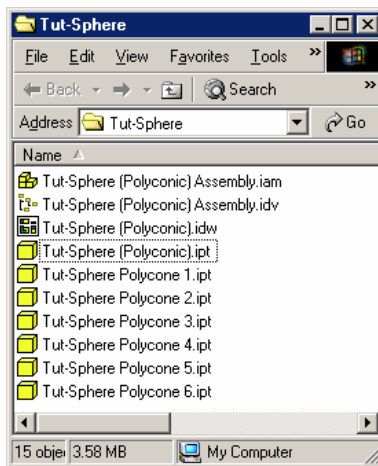

Figure 6B-8I:
Save A Copy As 6 files.

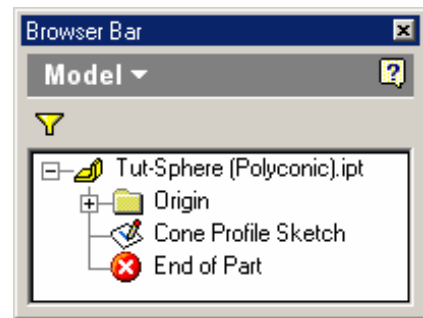

Figure 6B-8J: the Model panel features.

For the top conical section, there is a small modification to the above-mentioned basic procedures. In order to create a vertex relief opening at the top of the spherical surface, modify the top conical section close to the North Pole vertex point of the profile sketch; use the **Line** tool to draw a vertical line on the right of the centerline; use the **General Dimension** tool to apply a $\phi 1.00$ -inch dimension between the two vertical lines; use the **Line** tool to draw a line from the intersecting point between the vertical line and inner edge line of the top conical section's profile, and perpendicular to the outer edge line, with the help of the **Perpendicularity** constraint indicator; use the **Trim** tool to trim off all unneeded line segments and complete the top section of the profile (*Figure 6B-8G*). The basic *Cone Profile Sketch* is complete (*Figure 6B-8H*); click the **Return** button to exit the *Cone Profile Sketch*; save the file as *Tut-Sphere (Polycon).ipt* in the same *Tut-Sphere* folder created in *Module 6A*; and go to **File**→**Save A Copy As** menu to save 6 copies as *Tut-Sphere Polycon 1.ipt*, *Tut-Sphere Polycon 2.ipt*, *Tut-Sphere Polycon 3.ipt*, *Tut-Sphere Polycon 4.ipt*, *Tut-Sphere Polycon 5.ipt*, and *Tut-Sphere Polycon 6.ipt* in the same *Tut-Sphere* folder (*Figure 6B-8I*). Close the *Tut-Sphere (Polycon).ipt* file. The features of the **Model** panel are shown in *Figure 6B-8J*.

Step 2: Editing the generic conical profile sketch in separate Sheet Metal (in).ipt part files to create poly-conical sheet metal parts

Next, edit the generic *Cone Profile Sketch* in separate “**Save A Copy As**” **Sheet Metal (in).ipt** part files to create poly-conical sheet metal parts. Open each of the 6 Save A Copy As files; click-select the *Cone Profile Sketch* in the **Model** panel, right-click for the shortcut menu and choose the **Edit Sketch** option; add the number of the cone to the name of the Sketch feature in each Save A Copy As file (such as “*Cone 1 Profile Sketch*,” etc.); delete the unneeded segment of the profile with the **Delete** key on the keyboard and leave only the one that is relevant to the conical section in each file (*Figure 6B-9A*, *Figure 6B-10A*, *Figure 6B-11A*, *Figure 6B-12A*, *Figure 6B-13A* and *Figure 6B-14A*); click the **Return** button to exit the respective sketch. Save the files often at each step of the entire project.

Next, select the **Revolve** tool, choose **Join** as **Type**, the relevant *Cone X Profile Sketch* as **Profile**, the vertical centerline as the **Axis**, and **Midplane** as **Direction** to create conical sections of the spherical surface in each of the “**Save A Copy As**” files (*Figure 6B-9B*, *Figure 6B-10B*, *Figure 6B-11B*, *Figure 6B-12A*, *Figure 6B-13B* and *Figure 6B-14B*), with different **Angles** of revolution listed in the following table, and rename the **Revolve** features in the **Model** panel accordingly:

File	Sketch Name	Revolve Feature Name	Angle
<i>Tut-Sphere Polycon 1.ipt</i>	Cone 1 Profile Sketch	Polycone 1	359.9°
<i>Tut-Sphere Polycon 2.ipt</i>	Cone 1 Profile Sketch	Polycone 2	359.9°
<i>Tut-Sphere Polycon 3.ipt</i>	Cone 1 Profile Sketch	Polycone 3	120°
<i>Tut-Sphere Polycon 4.ipt</i>	Cone 1 Profile Sketch	Polycone 4	120°
<i>Tut-Sphere Polycon 5.ipt</i>	Cone 1 Profile Sketch	Polycone 5	90°
<i>Tut-Sphere Polycon 6.ipt</i>	Cone 1 Profile Sketch	Polycone 6	90°

Next, click-select the outer surface of each conical section **Revolve** feature and click the **Flat Pattern** tool to create the **Flat Patterns** view (*Figure 6B-9C, Figure 6B-10C, Figure 6B-11C, Figure 6B-12C, Figure 6B-13C and Figure 6B-14C*).

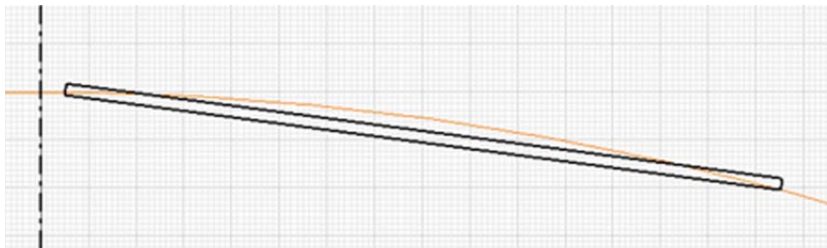

Figure 6B-9A: The Cone 1 Profile Sketch with added "vertex relief" opening.

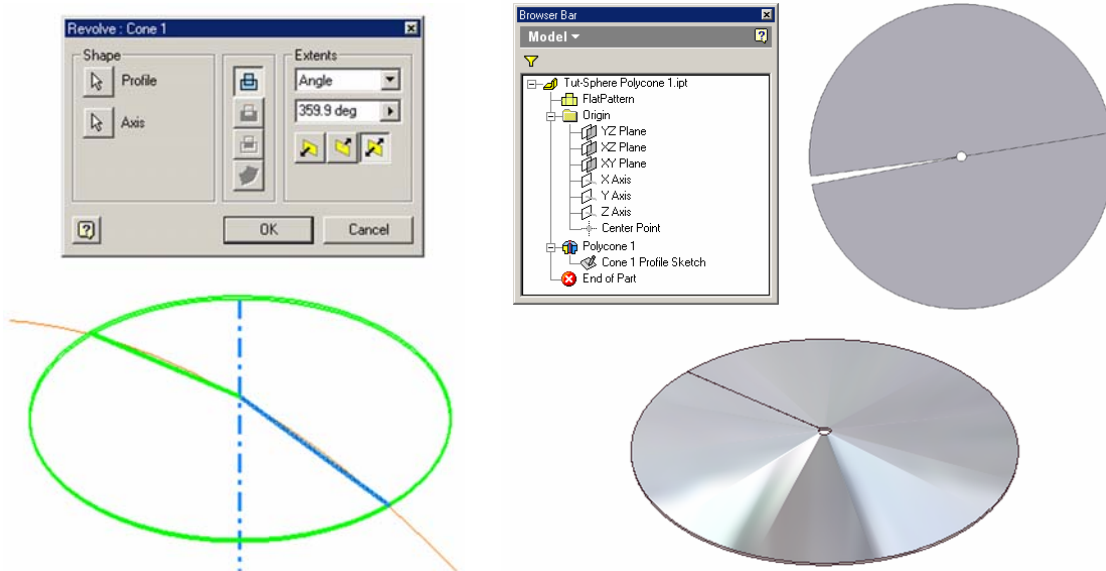

Figure 6B-9B: The Polycone 1 Revolve feature.

*Figure 6B-9C: The Polycone 1's 3D folded model, flat pattern and **Model** panel features.*

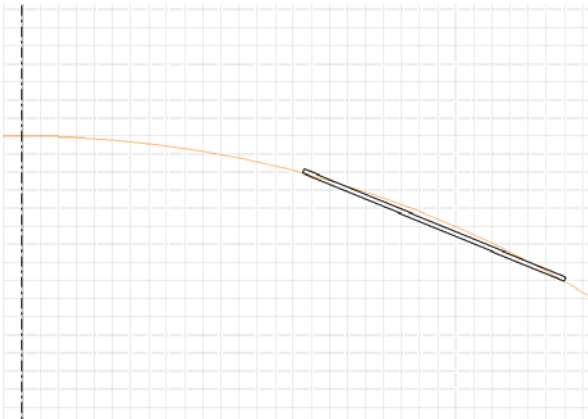

Figure 6B-10A:
The Polycone 2 Profile Sketch.

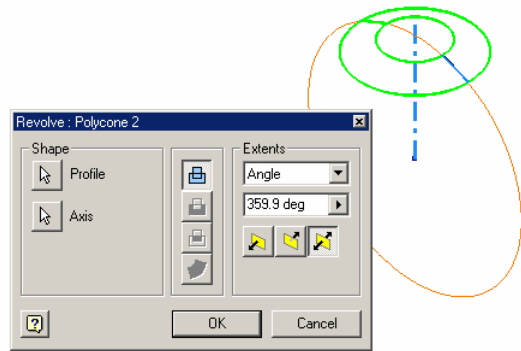

Figure 6B-10B: The Polycone 2
Revolve feature.

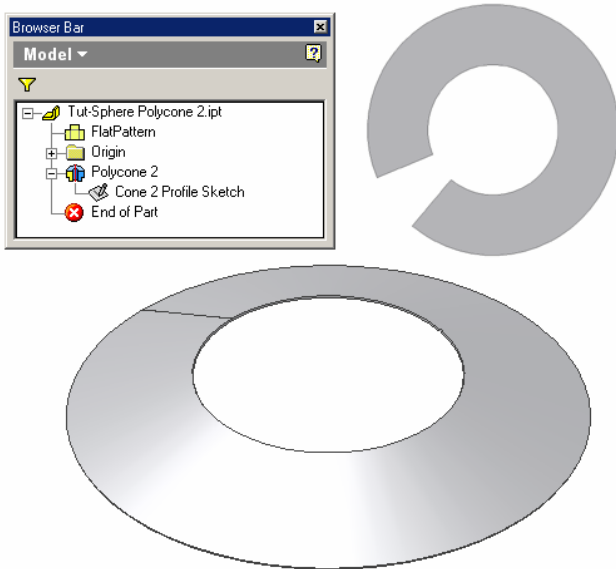

Figure 6B-10C: The Polycone 2's 3D folded model, flat pattern and **Model** panel features.

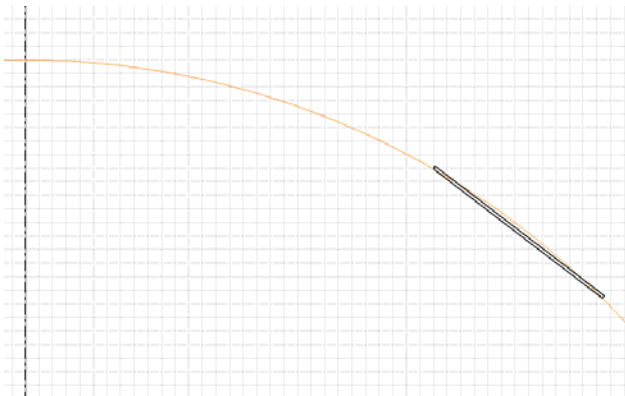

Figure 6B-11A: The Polycone 3 Profile Sketch.

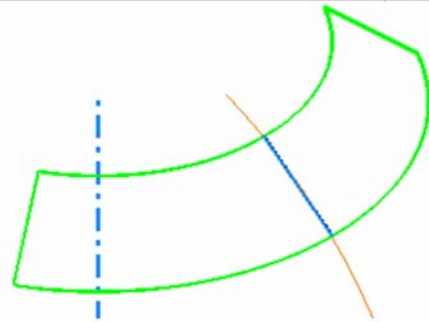
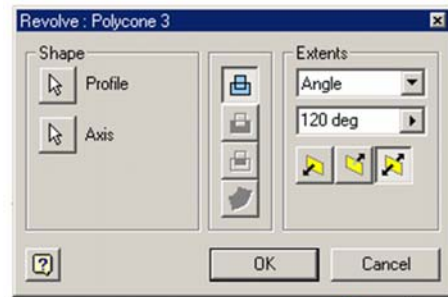

Figure 6B-11B: The Polycone 3 Revolve feature.

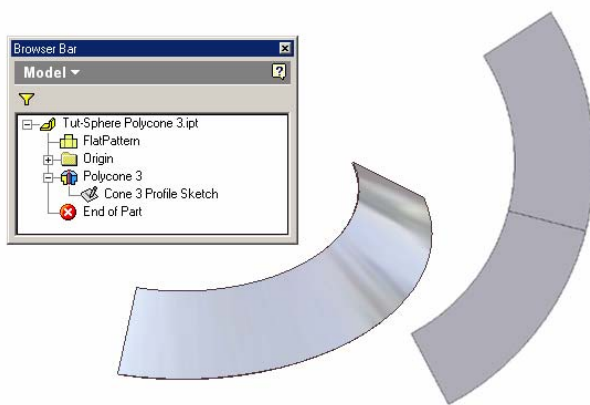

Figure 6B-11C: The Polycone 3's 3D folded model, flat pattern and **Model** panel features.

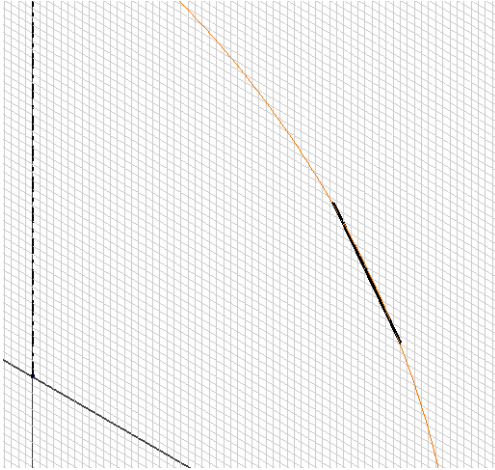

Figure 6B-12A: The Polycone 4 Profile Sketch.

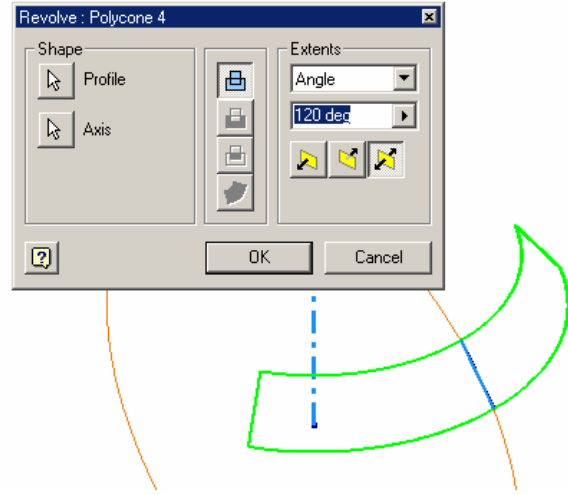

Figure 6B-12B: The Polycone 4 Revolve feature.

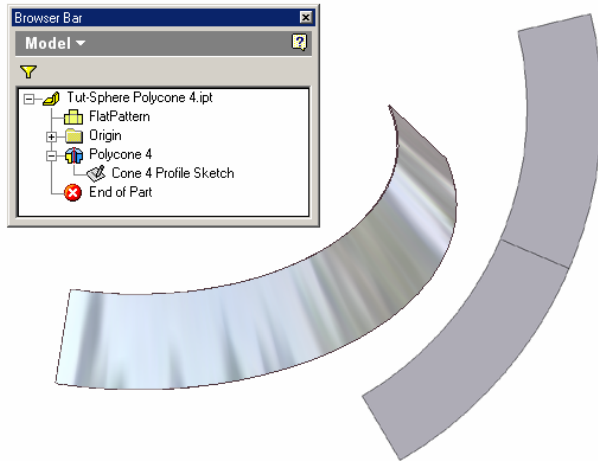

Figure 6B-12C: The Polycone 4's 3D folded model, flat pattern and Model panel features.

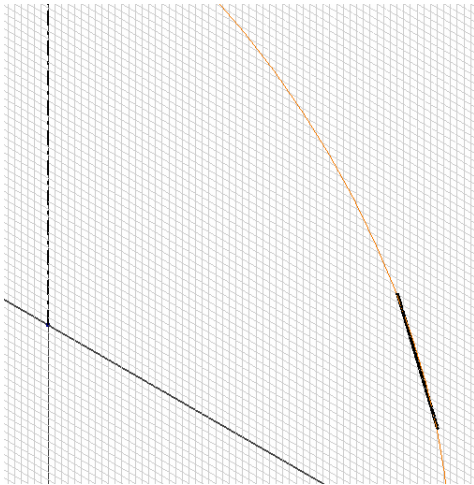

Figure 6B-13A: The Polycone 5 Profile Sketch.

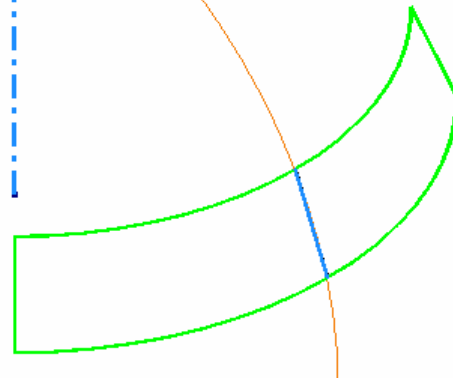
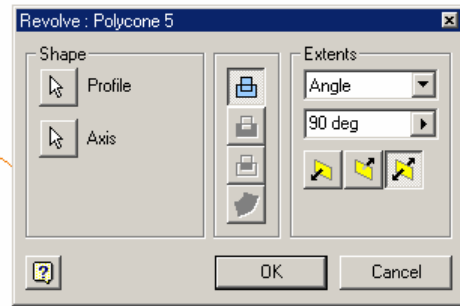

Figure 6B-13B:
The Polycone 5 **Revolve** feature.

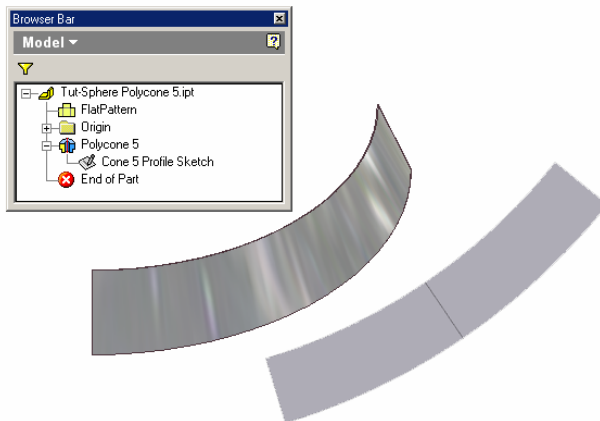

Figure 6B-13C: The Polycone 5's 3D folded model, flat pattern and **Model** panel features.

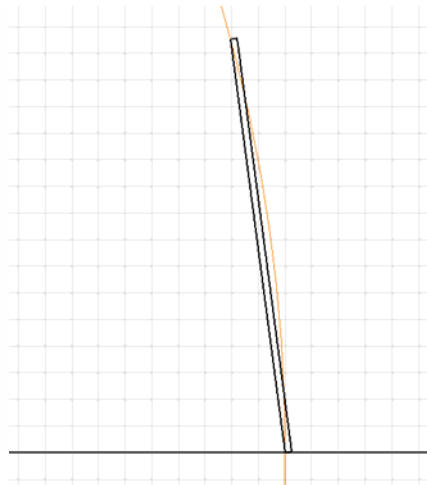

Figure 6B-14A: The Polycone 6 Profile Sketch.

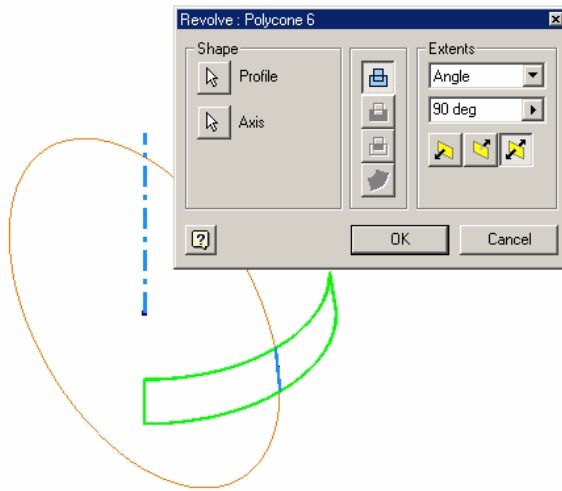

Figure 6B-14B: The Polycone 5 Revolve feature.

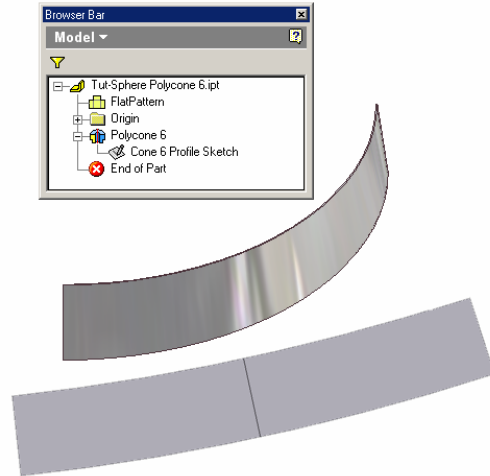

Figure 6B-14C: The Polycone 6's 3D folded model, flat pattern and Model panel features.

Step 3: Assembling the poly-conical sheet metal parts to cover the domical space

Start a new Inventor **Standard (in).iam** assembly file under **English** tab; save it as *Tut-Sphere (Gore) Assembly.iam* in the same *Tut-Sphere* folder. Use the **Place Component** tool to place the 3D models of all *Tut-Sphere Polycon 1.ipt*, *Tut-Sphere Polycon 2.ipt*, *Tut-Sphere Polycon 3.ipt*, *Tut-Sphere Polycon 4.ipt*, *Tut-Sphere Polycon 5.ipt*, and *Tut-Sphere Polycon 6.ipt* files into the assembly file.

Next, use the **Place Constraint** tool with **Mate** as **Type** and **Flush** as **Solution** to mate the **XY Plane**, **YZ Plane** and **XZ Plane** of each of these files with their corresponding **Planes** in the assembly file.

Next, select the **Pattern Component** tool and the **Circular** tab in the tool's dialog window (*Figure 6B-15A*) to pattern the following conical sections by various values for **Count** and **Angle**:

Placed Component File	Count	Angle
<i>Tut-Sphere Polycon 3.ipt</i>	3	120°
<i>Tut-Sphere Polycon 4.ipt</i>	3	120°
<i>Tut-Sphere Polycon 5.ipt</i>	4	90°
<i>Tut-Sphere Polycon 6.ipt</i>	4	90°

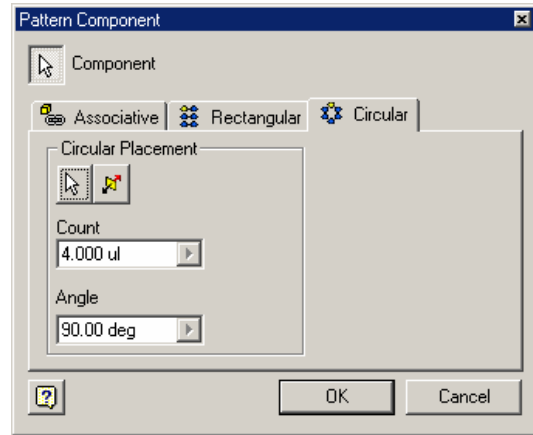

*Figure 6B-15A (Right): The **Pattern Component** tool dialog window with **Circular** tab option.*

The various orthographic and isometric views of the assembly are shown on *Figure 6B-15B*. The features of the assembly are listed in the **Model** panel (See *Figure 6B-15C*).

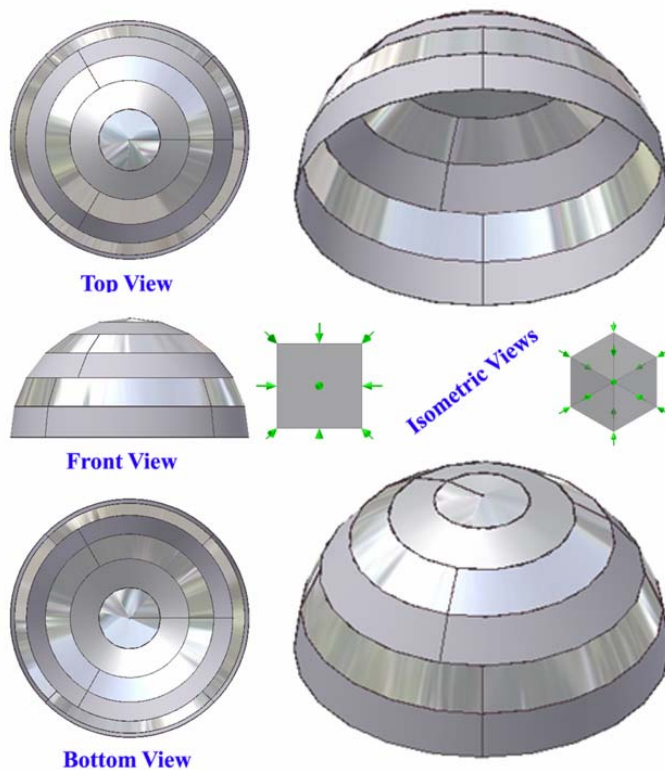
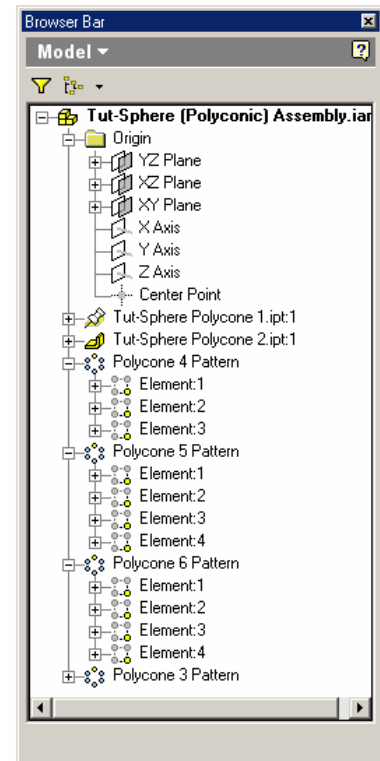

Figure 6B-15B: The complete assembly.



*Figure 6B-5C: The **Model** panel of the assembly file.*

Congratulations! In the *Modules 6A* and *6B*, you have learned the skills of creating single-curved poly-cylindrical (“Gore”) and poly-conical sections as substitutes for the non-developable double-curved spherical surfaces, in two real-world sheet metal design projects used in the construction of an astronomy observatory dome.