

Module 1F: Creating a Circle-Based Cylindrical Sheet-metal Part With Locking Seams on the Lateral Edges

In *Module 1A*, we have explored the method of creating a cylindrical sheet metal part using the **Revolve** tool; with this method, a tiny gap is created along the seams of the lateral piece. In practical design, this method is suitable for situations where the folded-up lateral piece is to be welded; however, there are occasionally situations where the folded-up lateral piece is to be mechanically connected by a locking seam piece (*Figure 1F-1A*). In this *Module*, we will learn how to create a 24.0-inch diameter cylindrical sheet metal lateral piece with locking seams inside the cylindrical space, using the **Contour Flange** tool.

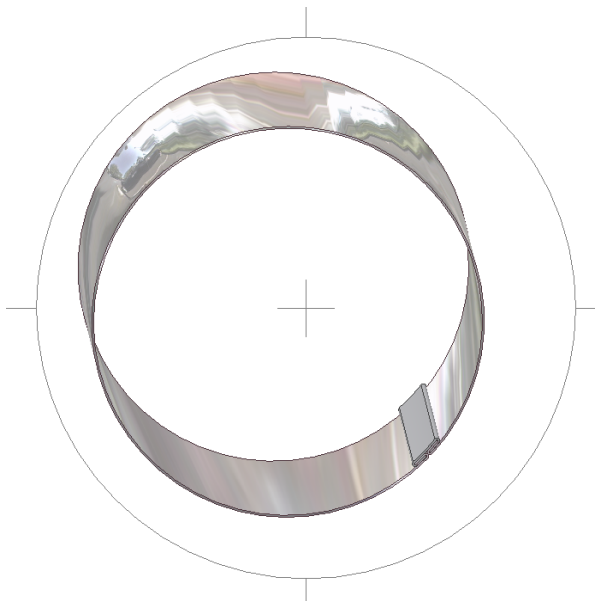

Figure 1F-1A: The cylindrical sheet metal lateral piece with locking seam, created with the Contour Flange tool.

Section 1: ***Creating A Cylindrical Sheet Metal Part with Locking Seams***

Step 1: Construct the circular base profile with locking seams

First, we will create a sheet metal file with inch as units. Launch Autodesk Inventor. Create a new sheet metal file (go to the menu **File**→**New**, or click on the **New** icon on **Standard Tool Bar**. The Open window appears. Select the **English** tab; then select the **Sheet Metal (In).ipt** template, click **OK** button (*Figure 1F-1B*).

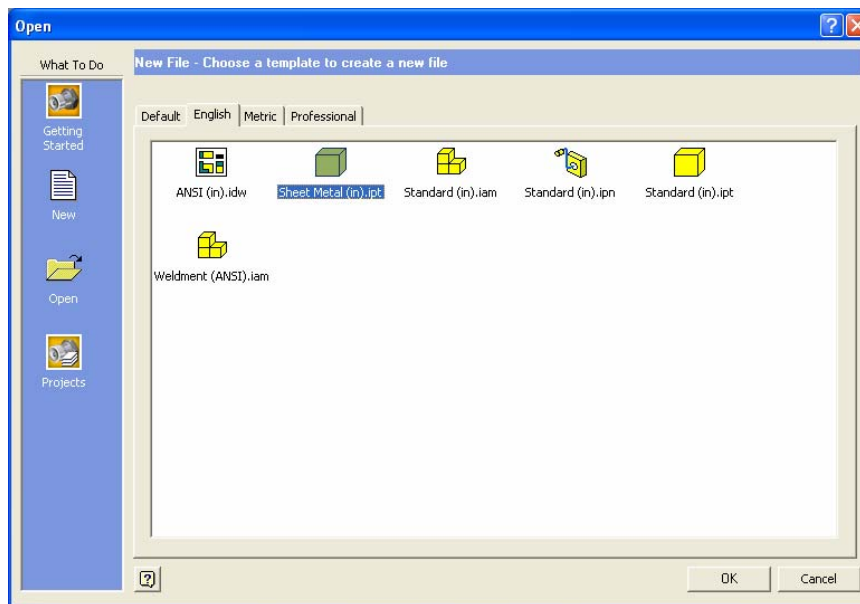

Figure 1F-1B:
Starting a new
Sheet Metal
(In).ipt file.

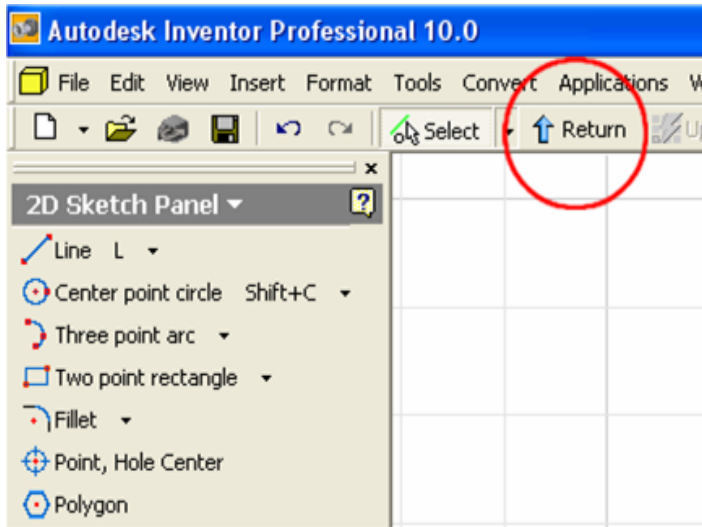

Figure 1F-1C: Dismissing the default Sketch1 by clicking the Return button.

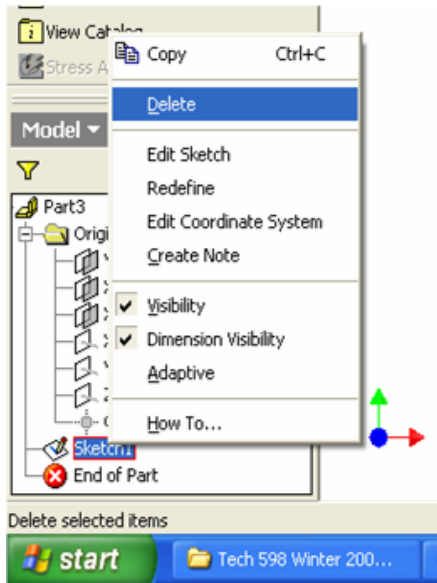

Figure 1F-1D: Deleting the default Sketch1.



Figure 1F-1E: Switching to Isometric View.

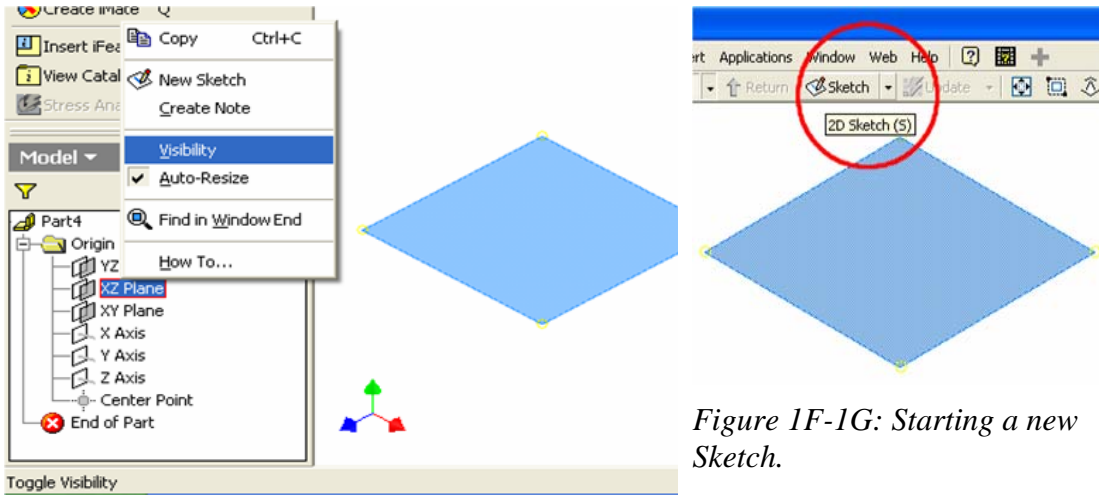

Figure 1F-1G: Starting a new Sketch.

Figure 1F-1F: Turning on the Visibility option.

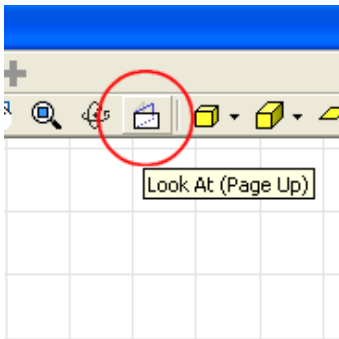

Figure 1F-1G: Switching to an orthographic view.

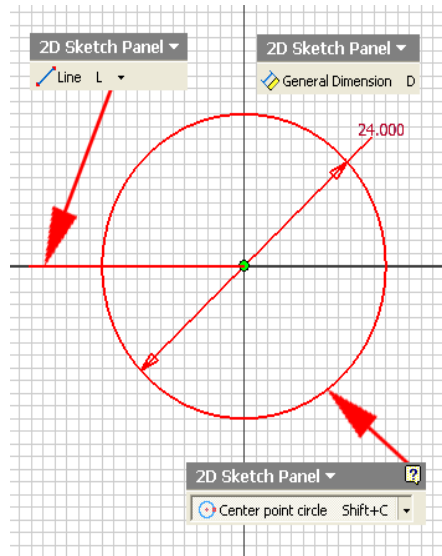

Figure 1F-2A: Creating the 24-inch diameter “cylinder circle” and the horizontal line starting from the projected Center Point leftward.

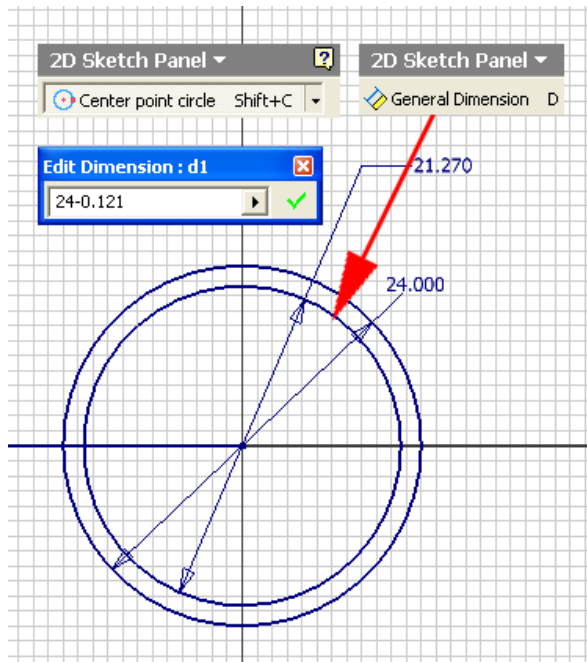

Figure 1F-2B: Creating the $24-0.121 = 23.879$ -inch diameter “locking seam circle.”

A new sheet metal file opens with two panels docked on the left side of the screen: **2D Sketch** (top) and **Model** (bottom). The *Sketch1* opens automatically on the screen; and *Sketch1* feature appears on the **Model** panel. Click the **Return** button in the **Inventor Standard** tool bar (Figure 1F-1C) to dismiss the *Sketch1* feature.

In the **Model** panel, click the cross on the left of the **Origin** folder to view the **Planes**, **Axis** and **Center Point** features; click-select the *Sketch1* feature and right-click for the shortcut menu and choose the **Delete** option to delete it (Figure 1F-1D). Next, go to the View→Isometric menu to switch to an isometric view (Figure 1F-1E). Next, select the **XZ Plane**, then right-click to open the short cut menu and check the **Visibility** option (Figure 1F-1F). Next, click-select the **XZ Plane** and then the **Sketch** button on the **Inventor Standard** tool bar to start a new sketch (Figure 1F-1G); **Sketch2** feature appears in the **Model** panel; highlight the **Sketch2** name and type *Base Profile* to rename it.

Next, click-select the **XZ Plane** and then the **Look At** tool button in the **Inventor Standard** tool bar to switch to an orthographic normal view (Figure 1F-1H). Now, we are ready to start the elliptical base profile.

Click-select the **Project Geometry** tool from the **2D Sketch** tool panel and then the **Center Point** from the **Model** panel to project it onto the *Base Profile Sketch*; a green dot appears on the center of the *Base Profile Sketch*; next, select the **Center Point**

Circle tool from the **2D Sketch** tool panel and create a horizontal line starting from the projected **Center Point**; use the **General Dimensions** tool to apply a 24-inch diameter dimension. Next, use the **Line** tool to create a horizontal line starting at the projected **Center Point** and ending at a convenient location on the right of the circle (*Figure 1F-2A*); next, select the **Center Point Circle** tool again, create a smaller circle (“locking seam circle”) centered at the projected **Center Point**; select the **General Dimension** tool and click-select the “locking seam circle” to apply a diameter dimension, double-click the dimension feature to open up the dimension text field and type 24-0.121 to apply a 23.879-inch diameter dimension (*Figure 1F-2B*). In this step, 24.0-inch is the diameter of the cylindrical sheet-metal part; since the locking seam is placed inside the cylindrical space, we subtract 0.12-inch for the thickness of the sheet-metal material (for the separate locking seam to be inserted into the space) and 0.001 for a tiny gap. We do not need to make a calculation before applying the dimensional value in the **General Dimension** tool’s text field; we can simply type in the formula using the following symbols: + for addition; - for subtraction; * for multiplication; / for division; and after we click the green check mark, Inventor will compute the result and apply the correct dimension (See *Figure 1F-2C*).

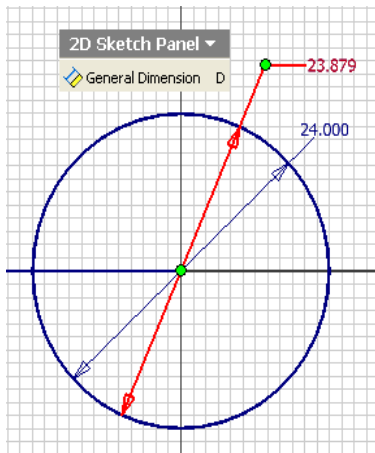

Figure 1F-2C: Inventor computing the result and applying the correct dimension.

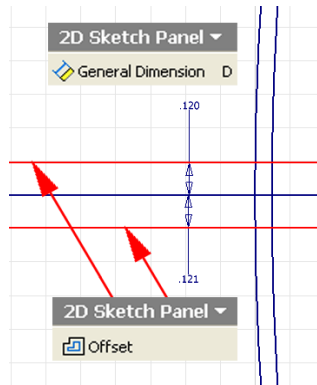

Figure 1F-2D: Creating two Offset lines and applying height dimensions.

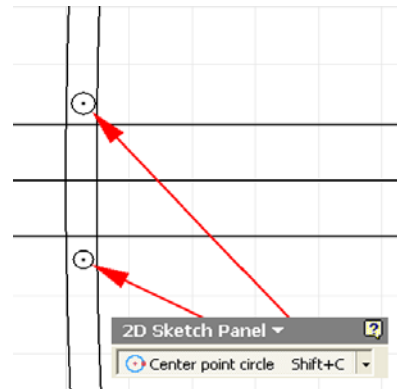

Figure 1F-2E: Creating two tiny circles to be trimmed into fillets in latter steps.

Next, select the **Offset** tool; click the existing horizontal line and then a convenient location above it to create an offset line; click the existing horizontal line and then a convenient location below it to create another offset line; next, select the **General Dimension** tool to apply a 0.120-inch height dimension between the original horizontal line and the offset line above it; and a 0.121-inch, or 0.120-inch thickness of sheet-metal

material plus a 0.001-inch gap (*Figure 1F-2D*). Next, select the **Center Point Circle** tool to create two small circles at convenient locations within the space as shown in *Figure 1F-2E*. Next, select the **Tangent** tool, click-select three pairs of entities to change the diameter of the tiny circle: tiny circle with “locking seam circle;” tiny circle with “cylinder circle;” and tiny circle with the offset horizontal line; this causes the diameter of the tiny circles to change into larger sizes that are in tangency with all three entities (“locking seam circle,” “cylinder circle,” and the offset line), as shown in *Figure 1F-2F*.

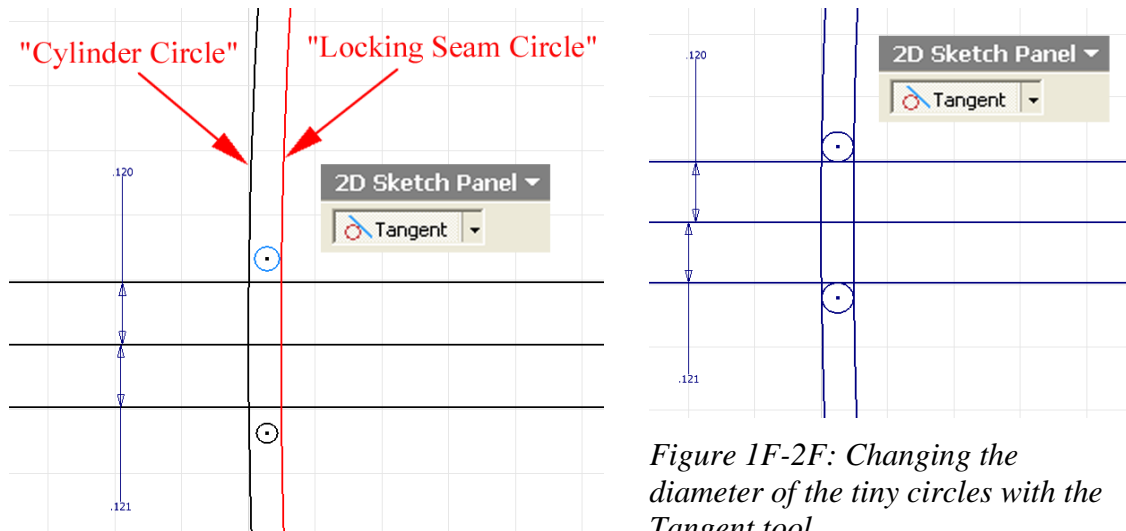

Figure 1F-2F: Changing the diameter of the tiny circles with the Tangent tool.

Next, click-select the two offset horizontal lines and press the **Delete** key on the keyboard to delete them; select the **Trim** tool to trim off the excessive segments of the two small circles and the two large circles as shown in *Figure 1F-2G* and *Figure 1F-2H*; next, select the **Line** tool to create a vertical line connecting the center points of the two trimmed off small circles; select the **Center Point Circle** tool again to create a circle centered at the midpoint of the vertical line, clicking at the midpoint when the green dot snap indicator appears (*Figure 1F-2J*); select the **General Dimension** tool to apply a 2.00-inch diameter dimension (corresponding to slightly less than 1.00-inch cord length for the seams), as shown in *Figure 1F-2J*. Next, select the **Trim** tool to trim off the unneeded portion of the “locking seam circle” (*Figure 1F-2L*); right-click to open the shortcut menu and choose the **Done** option to exit the tool (*Figure 1F-2M*). Next,

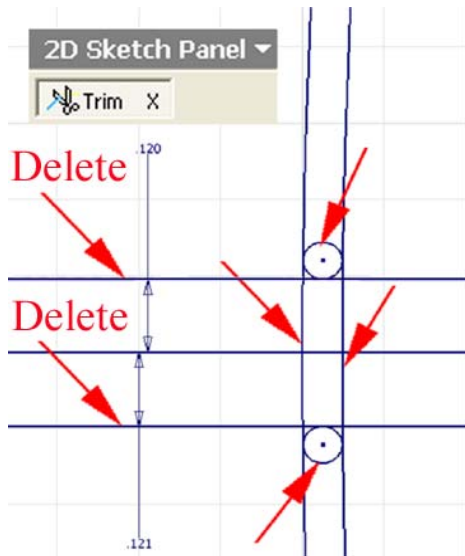

Figure 1F-2G: Selecting and deleting the offset horizontal line; and trimming off the excessive segments of the two small circles and of the two large circles.

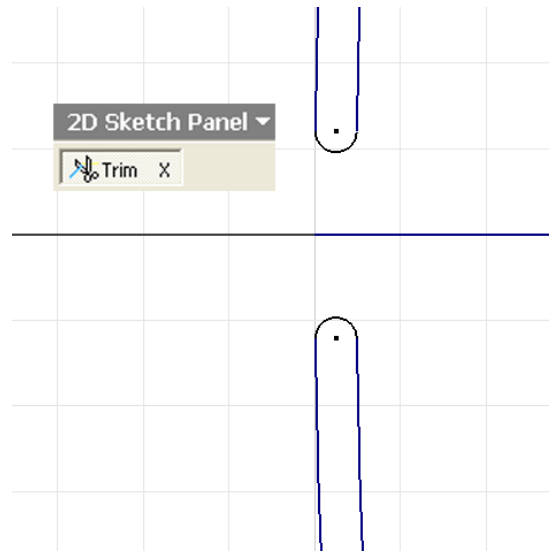

Figure 1F-2H: The remaining profile after the trimming off of unneeded arc segments.

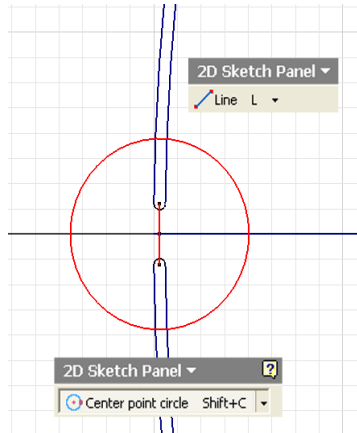

Figure 1F-2J: Creating the vertical line and the new circle.

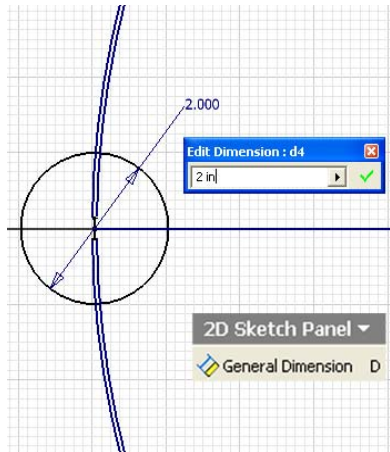

Figure 1F-2K: Applying a 2.00-inch diameter dimension.

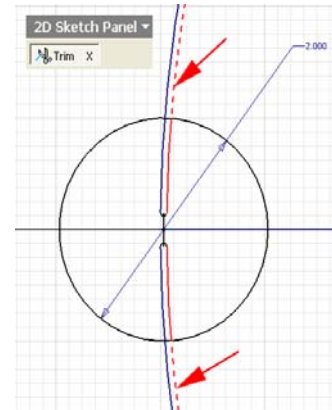

Figure 1F-2L: Trimming off the unneeded portion of the “locking seam circle.”

Next, click-select the vertical line and the circle, and press the **Delete** key on the keyboard to delete them (Figure 1F-2N). Next, click-select the horizontal line drawn from the projected **Center Point** leftward and click the **Construction** button on the **Inventor Standard** tool bar to change its line **Style** to **Construction** (Figure 1F-2P).

The profile for the cylindrical sheet-metal part with locking seams is complete; click the **Return** button on the **Inventor Standard** tool bar to exit the **Sketch** mode; go to the **View→Isometric** menu to switch to an isometric view (*Figure 1F-2Q*).

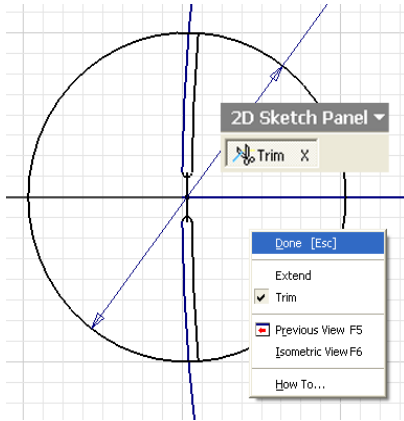

Figure 1F-2M: Exiting the Trim tool with the shortcut menu.

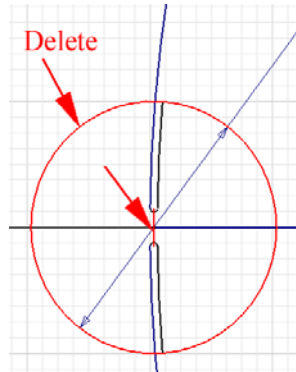

Figure 1F-2N: Deleting the vertical line and the circle.

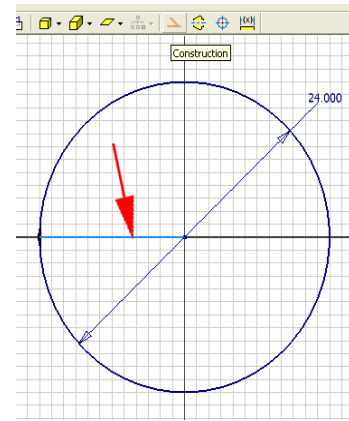

Figure 1F-2P: Changing the line Style of the horizontal line to Construction.

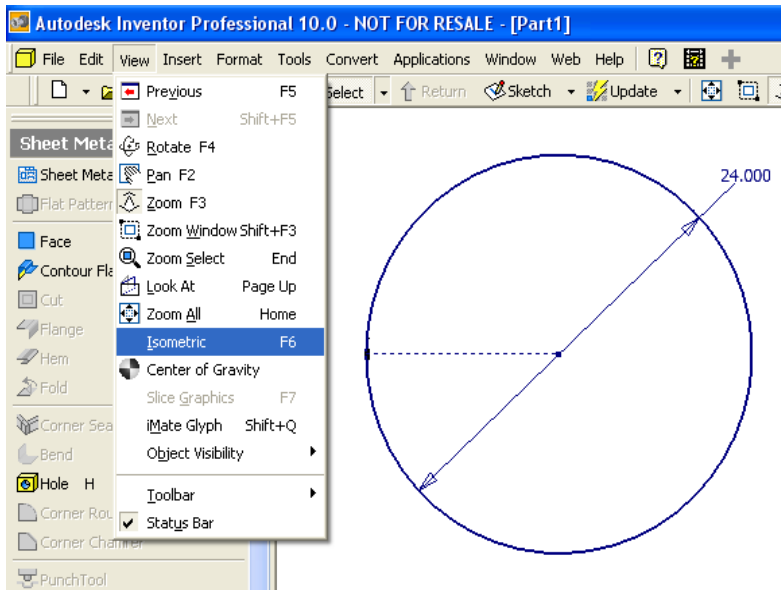
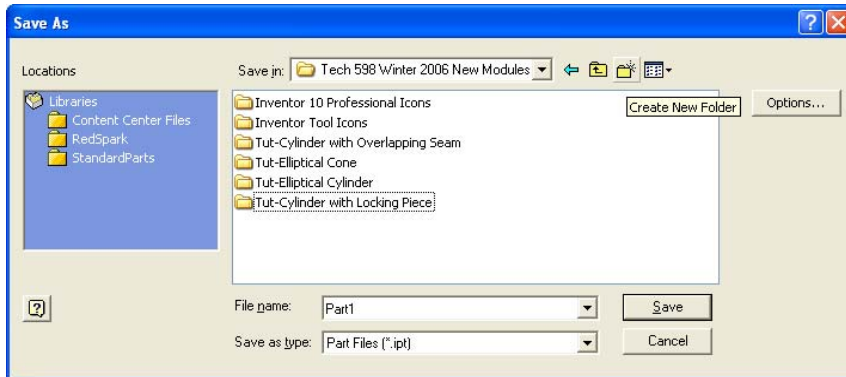
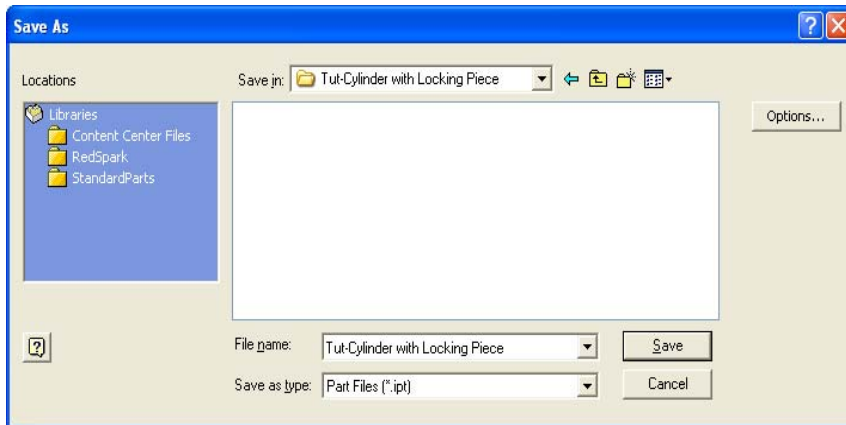

Figure 1F-2Q: Exiting the Sketch mode and switching to an isometric view.



*Figure 1F-2R:
Creating a new folder in the Save As window.*

Next, start saving the file. Press **Ctrl** and **s** keys simultaneously to save the file; in the **Save As** window, click the **Create A New Folder** button to create a new folder in a convenient directory location; rename the folder as *Tut-Cylinder with Locking Piece* (*Figure 1F-2R*); double-click the folder to open it; type *Tut-Cylinder with Locking Piece* and choose **Part File (*.ipt)** in the **Save As Type** field; and click the **Save** button to save the file (*Figure 1F-2S*). Save often, at least at the end of each step.



*Figure 1F-2S:
Saving the file.*

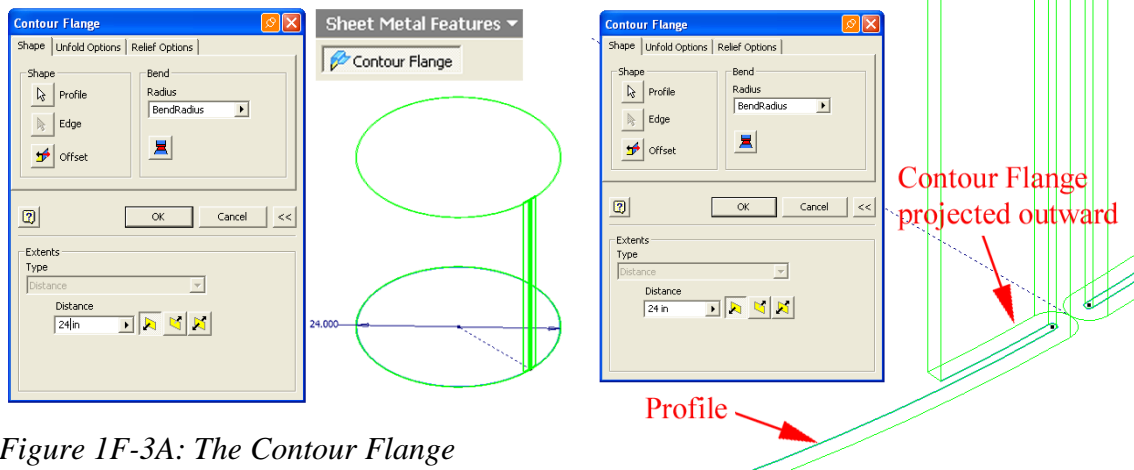

Figure 1F-3A: The Contour Flange geometry.

Figure 1F-3B: Making sure that the Contour Flange is projected outward.

Step 2: Creating the cylindrical sheet-metal piece with locking seams

Select the **Contour Flange** tool; click the **Profile** button in the tool's dialog window and click-select the profile just completed, the green outlines of the **Contour Flange** geometry appear on the screen (Figure 1F-3A); select the **Zoom Window** tool to zoom in the area of the locking seams, click the **Offset** button in the tool's dialog window to make sure that the **Contour Flange** is projected outward, as shown in Figure 1F-3B; click the **OK** button to create the **Contour Flange** feature and rename it *Cylindrical piece* in the **Model** pane. Save the file.

Next, click-select the outer surface of the *Cylindrical piece*, and click the **Flat Pattern** tool button in the **Sheet Metal Features** to create the **Flat Pattern** view; the **Flat Pattern** view window opens; close the **Flat Pattern** window so as to return to the 3D model screen by clicking the lower X box at the upper-right corner of the screen (Figure 1F-3C).

To apply a colorful rendering, go to the material list pull-down menu on the **Inventor Standard** tool bar and select any desired material (Figure 1F-3D). To view the cross-section of the locking seams, select the *Base Profile* from the **Model** panel and click the **Look At** button on the **Inventor Standard** tool bar (Figure 1F-3E). All features of the 3D model of the sheet-metal part are listed in the **Model** panel (Figure 1F-3F). Save and close the file.

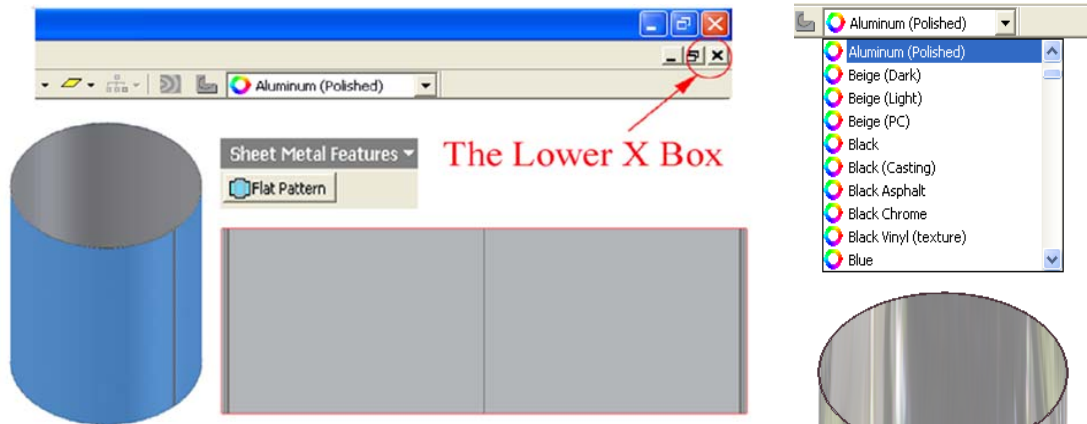

Figure 1F-3C: The Flat Pattern window and the Close Box.

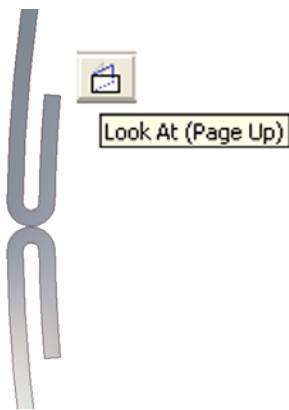

Figure 1F-3E: The cross-section of the locking seams.

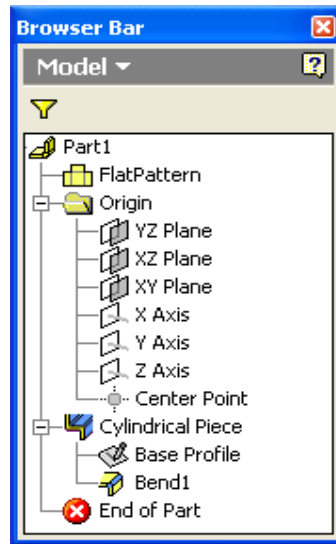

Figure 1F-3F: The features listed in the Model panel.

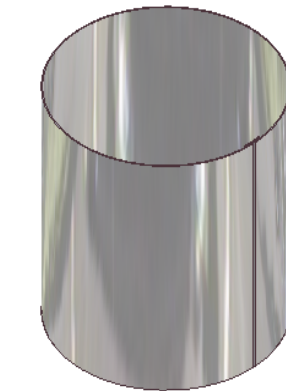

Figure 1F-3D: Applying a material, Aluminum (Polished) in this case.

Section 2:

Creating A Separate Locking Insert for The Cylindrical Sheet Metal Part

Step 1: Construct the base profile with locking insert

We will now create a separate locking insert that will be inserted into the locking seams of the cylindrical sheet-metal piece, in a separate **Sheet Metal.ipt** file. First, we will start a sheet metal file with inch as units. Launch Autodesk Inventor. Create a new

sheet metal file (go to the menu **File**→**New**, or click on the **New** icon on **Standard Tool Bar**. The Open window appears. Select the **English** tab; then select the **Sheet Metal (In).ipt** template, click **OK** button (*Figure 1F-4A*).

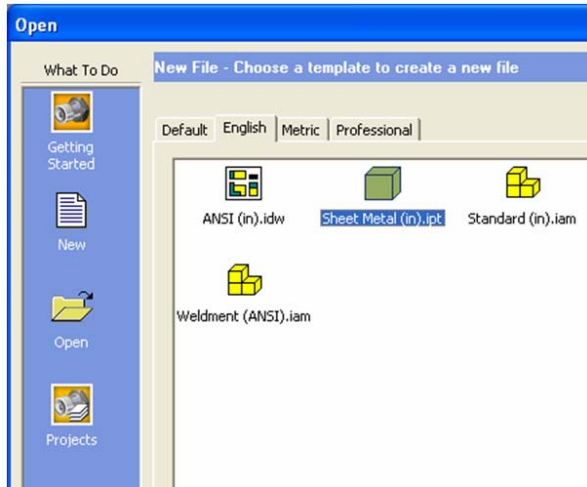

Figure 1F-4A: Starting a new Sheet Metal (In).ipt file.

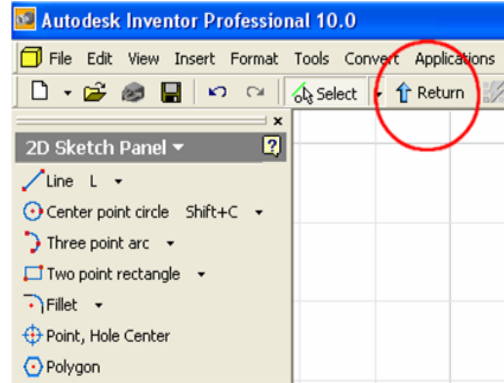

Figure 1F-4B: Dismissing the default Sketch1 by clicking the Return button.

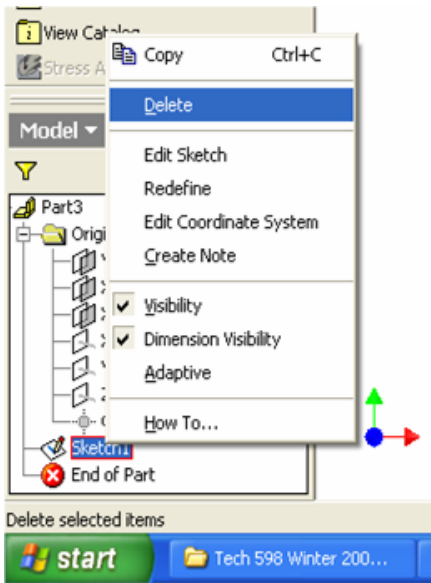

Figure 1F-4C: Deleting the default Sketch1.



Figure 1F-4D: Switching to Isometric View.

A new sheet metal file opens. The **Sketch1** opens automatically on the screen; and **Sketch1** feature appears on the **Model** panel. Click the **Return** button in the **Inventor Standard** tool bar (Figure 1F-4B) to dismiss the **Sketch1** feature.

In the **Model** panel, click-select the *Sketch1* feature and right-click for the shortcut menu and choose the **Delete** option to delete it (Figure 1F-4C). Next, go to the View→Isometric menu to switch to an isometric view (Figure 1F-4D).

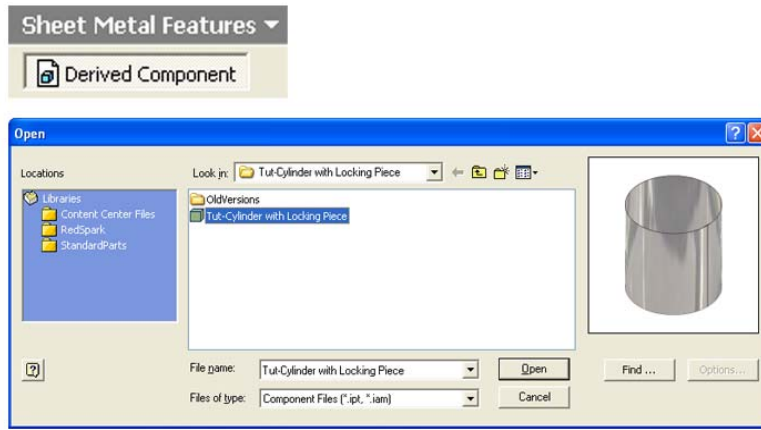

Figure 1F-4E: Opening a Derived Component file with the Derived Component tool.

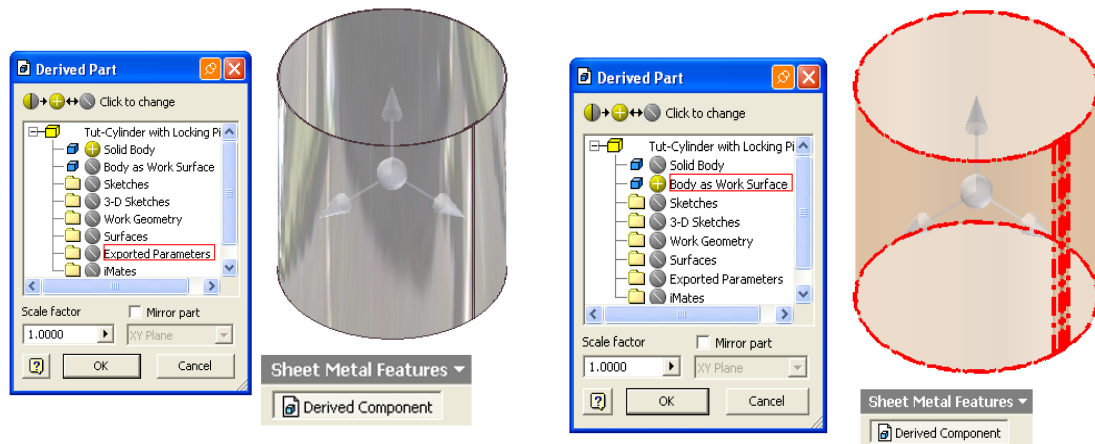

Figure 1F-4F: The Derived Part window.

Figure 1F-4G: Selecting the Body as Work Surface option.

Next, select the **Derived Component** tool from the **Sheet Metal Feature** or **Part Features** tool panel, the **Open** windows opens; select the *Tut-Cylinder with Locking Seams* file and click the **Open** button (Figure 1F-4E); the 3D model of the cylindrical

sheet-metal part appears on the screen and the **Derived Part** dialog windows opens (Figure 1F-4E); select the **Body as Work Surface** option and click the **OK** button; the 3D model becomes orange and transparent (Figure 1F-4G). Save the file as *Tut-Cylinder Locking Piece* in the same *Tut-Cylinder with Locking Seams* folder (Figure 1F-4H).

Next, select the **XZ Plane** from the **Model** panel and click the **Sketch** button from the **Inventor Standard** tool bar to start a new sketch (Figure 1F-5A and Figure 1F-5B); rename the default *Sketch1* in the **Model** panel as *Locking Insert Profile*. Next, click the **Look At** button on the **Inventor Standard** tool bar and then select the *Locking Insert Profile Sketch* from the **Model** panel to switch to an orthographic normal view (See Figure 1F-5C).



Figure 1F-4H: Saving the file.

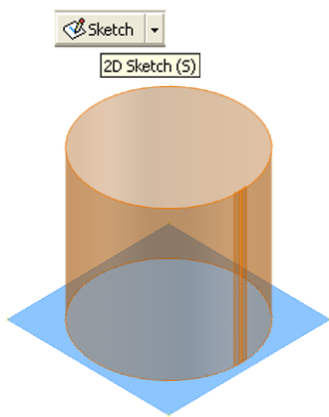

Figure 1F-5A: Selecting the XZ Plane and clicking the Sketch button.

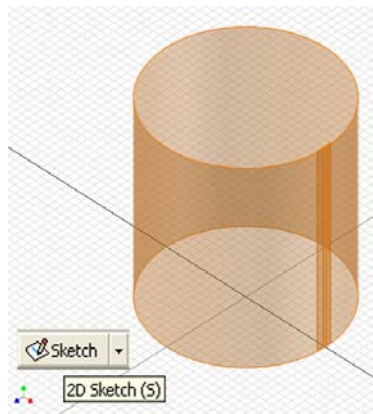

Figure 1F-5B: Starting a new sketch.

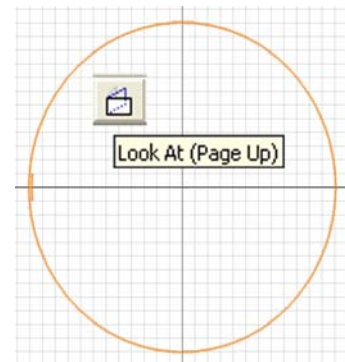

Figure 1F-5C: Switching to an orthographic normal view with the Look At tool.

Next, select the **Project Geometry** tool and project the relevant edge lines onto the sketch as shown in *Figure 1F-5D*; click once at a convenient lower-right corner, hold down the left mouse button and drag the mouse to a convenient upper-left corner and then release the left mouse button to window-select all projected lines, which turn blue (*Figure 1F-5E*), and right-click for the shortcut menu and choose the **Break Link** option (*Figure 1F-5F*), so as to change the projected geometry lines into editable normal lines.

Next, select the **Extend** tool to extend the curved line segment (*Figure 1F-5G*).

Next, select the **Center Point Circle** tool to create two circles to be trimmed into fillets connecting the bent pieces of the locking insert; select the midpoint of the straight line on the top for the center of the circle (*Figure 1F-5H*); then select the endpoint of this straight line for the radius of the circle (*Figure 1F-5J*); repeat the same procedures to create the other circle centered at the straight line at the bottom and with the radius established at the endpoint (*Figure 1F-5K*).

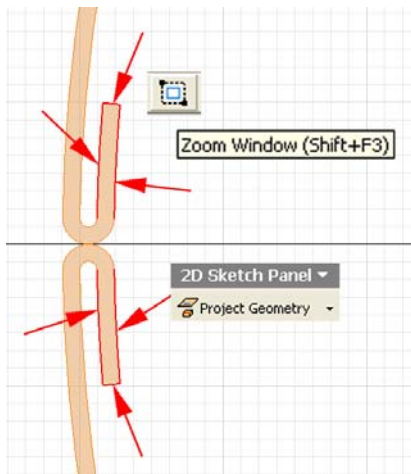

Figure 1F-5D: Projecting relevant geometry from the edges of the Derived Part.

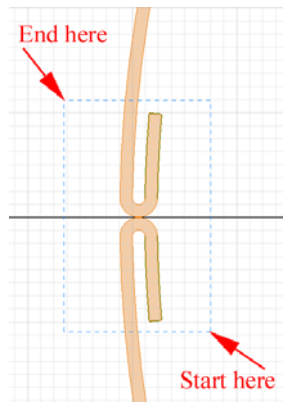

Figure 1F-5E: Window-selecting the projected geometry lines.

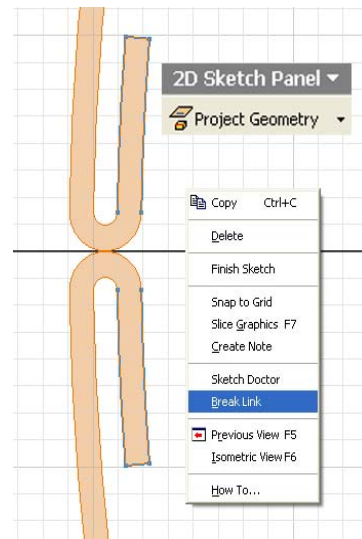

Figure 1F-5F: Changing the projected geometry lines into editable normal lines with the Break Link option.

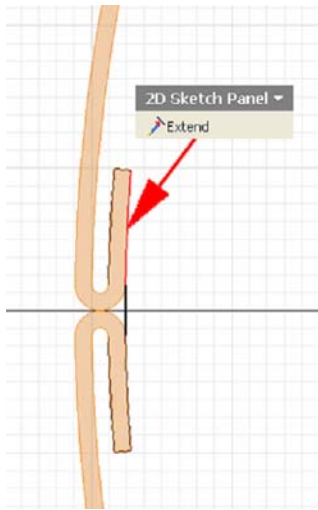

Figure 1F-5G:
Extending the curved
line segment.

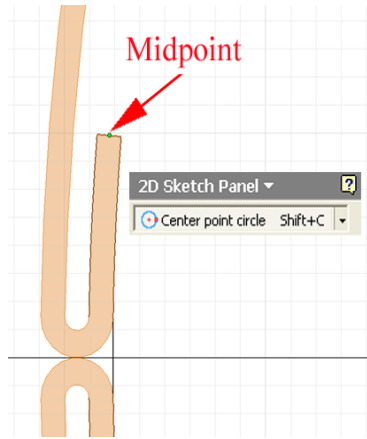

Figure 1F-5H: Selecting the
midpoint of the straight line
for the center of the circle.

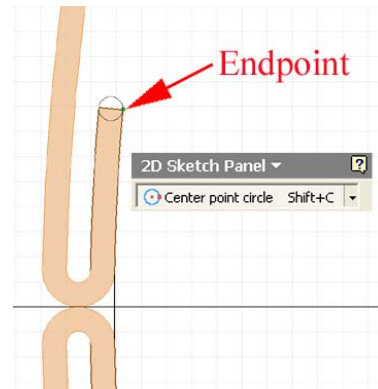

Figure 1F-5J: Selecting the
endpoint of the straight
line for the radius of the
circle.

Next, select the **Trim** tool to trim off both straight lines and both circles into fillets (Figure 1F-5L and Figure 1F-5M); right-click for the shortcut menu and choose the **Done [Esc]** option to exiting the Trim tool (Figure 1F-5N). The profile for the locking seam insert is completed. Click the **Return** button to exit the Sketch mode (Figure 1F-5P).

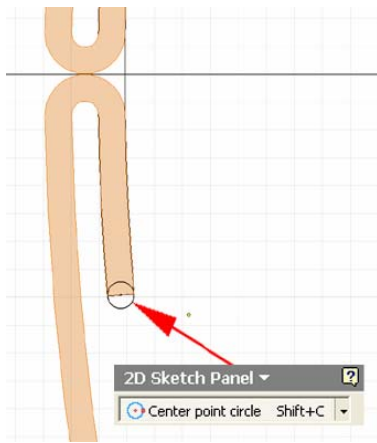

Figure 1F-5K: Creating the
other circle.

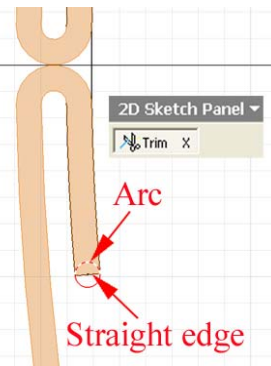

Figure 1F-5L:
Trimming the lower
circle into a fillet.

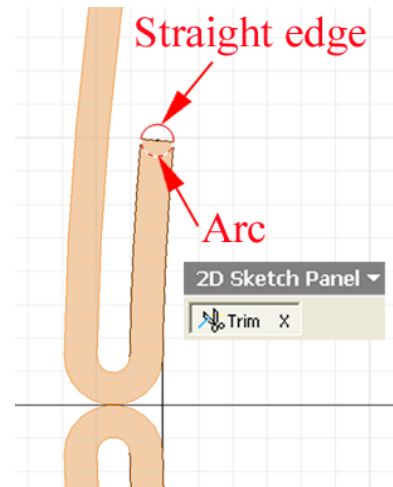

Figure 1F-5M: Trimming the
upper circle into a fillet.

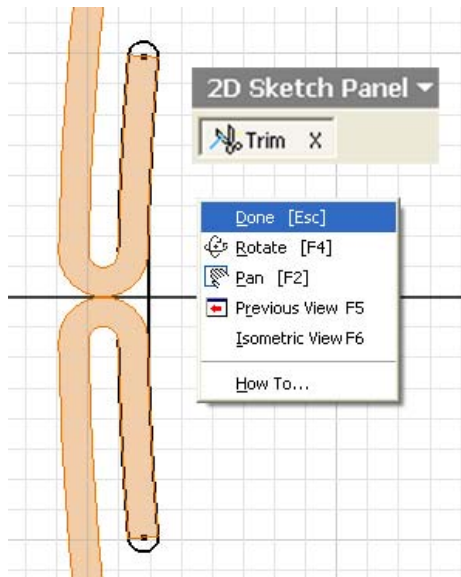

Figure 1F-5N: Exiting the Trim tool.

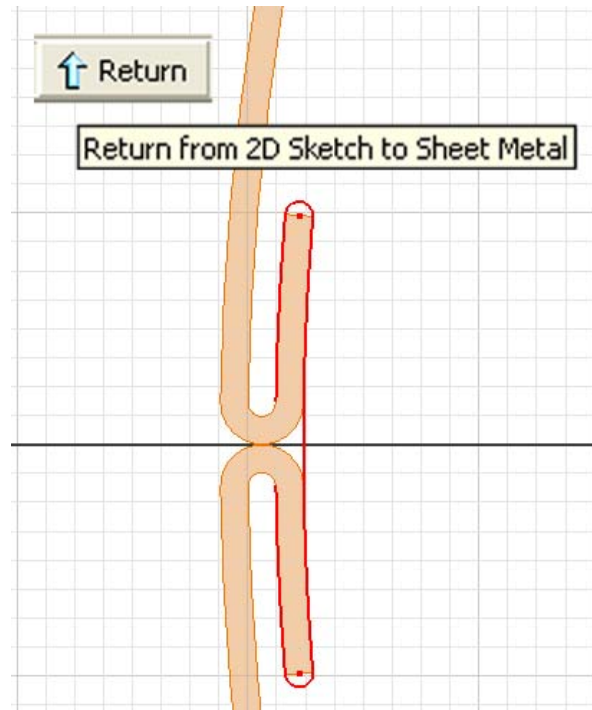

Figure 1F-5P: Exiting the Sketch mode.

Step 2: Creating the locking seam insert with the Contour Flange tool

Select the **Contour Flange** tool from the **Sheet Metal Features** tool panel; in the tool's dialog window, type 24 in (inches) in the **Distance** text field; click the profile to select it, the green outlines of the **Contour Flange** geometry appear on the screen; select the **Zoom Window** tool to zoom in the area of the profile, click the **Offset** button if needed to make sure that the **Contour Flange** is projecting outward from the profile curves (Figure 1F-6A); click the **OK** button to create the **Contour Flange** feature, and rename it as *Locking Insert* in the **Model** panel. Save the file.

Next, click the + box on the left of the *Tut-Cylinder with Locking Piece.ipt* feature in the **Model** panel to open it and to see the *Derived Work Body 1* feature; select the *Derived Work Body 1* feature and right-click for the shortcut menu, and uncheck the **Visibility** option (Figure 1F-6B); the transparent orange 3D model disappears from the screen. Next, click-select the outer surface of the 3D model of the locking insert, and click the **Flat Pattern** tool icon from the **Sheet Metal Features** tool panel to create the **Flat Pattern** view (Figure 1F-6C). All features of the 3D model are listed in the **Model** panel (Figure 1F-6D). Save and close the file.

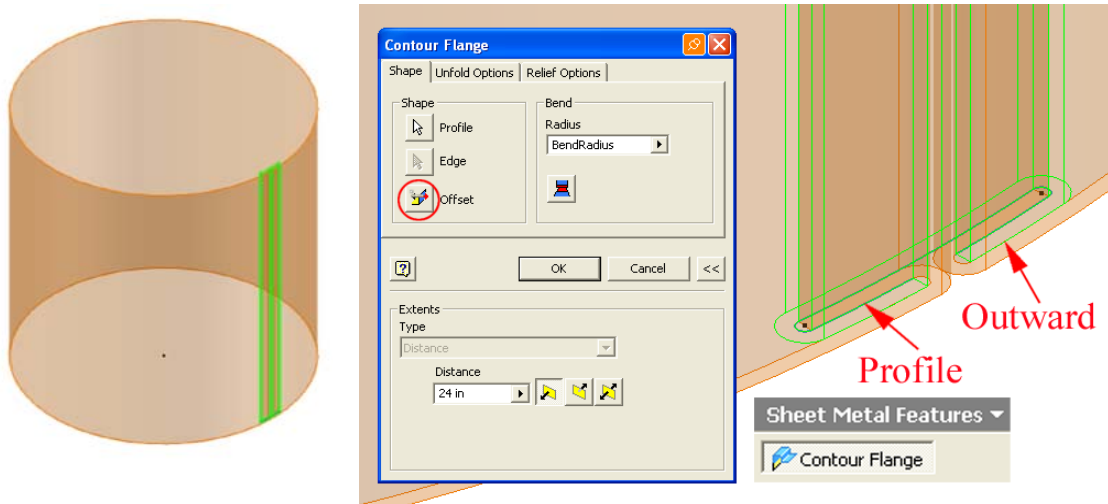

Figure 1F-6A: Creating a Contour Flange projecting outward from the profile, using the Offset button.

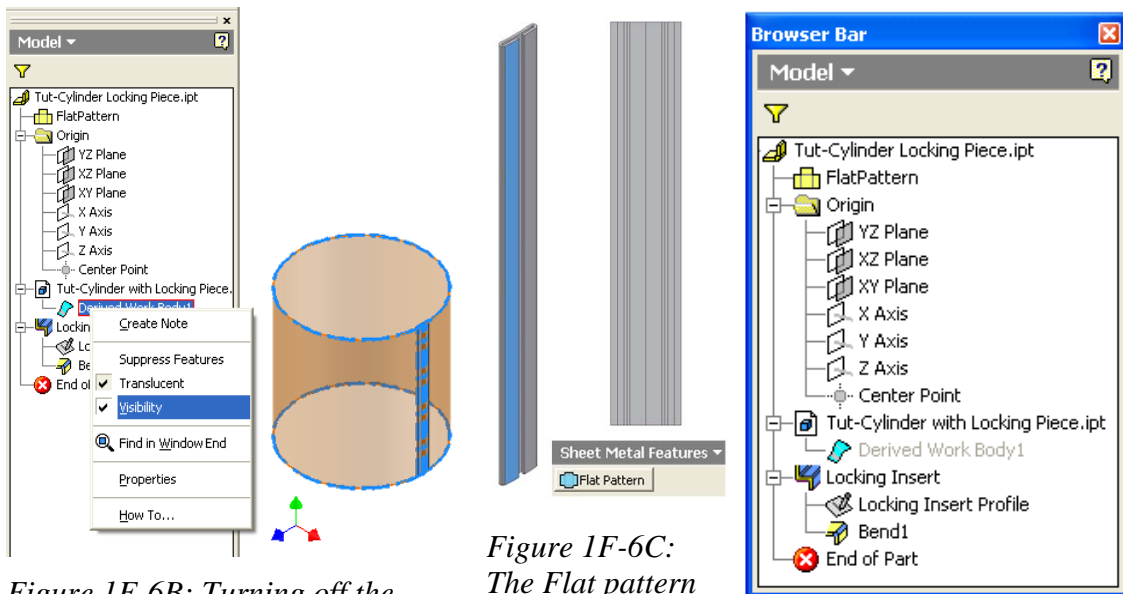

Figure 1F-6B: Turning off the Visibility of the Derived Body 1.

Figure 1F-6C: The Flat pattern view.

Figure 1F-6D: All features of the 3D model listed in the Model panel.

Section 3:

Assembling The Cylindrical Sheet Metal Part with The Locking Insert

We will now create an assembly file to the two parts together. Start a new assembly file (go to the menu **File**→**New**, or click on the **New** icon on **Inventor Standard** tool bar. The Open window appears. Select the **English** tab; then select the **Standard (in).iam** template, click the **OK** button (*Figure 1F-7A*).

Next, select the **Place Component** tool; the **Open** window of the **Place Component** tool opens; select the *Tut-Cylinder with Locking Piece* file inside the *Tut-Cylinder with Locking Piece* folder, and click the **Open** button (*Figure 1F-7B*); the 3D model of the *Tut-Cylinder with Locking Piece* file appears on the screen; click once to place one copy of the model; then right-click for the shortcut menu and choose the **Done** option to finish (*Figure 1F-7C*).

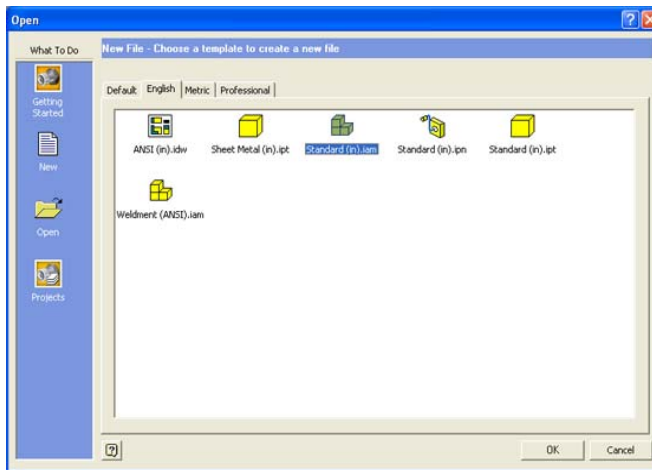

Figure 1F-7A: Starting an Inventor .iam assembly file under the English tab.

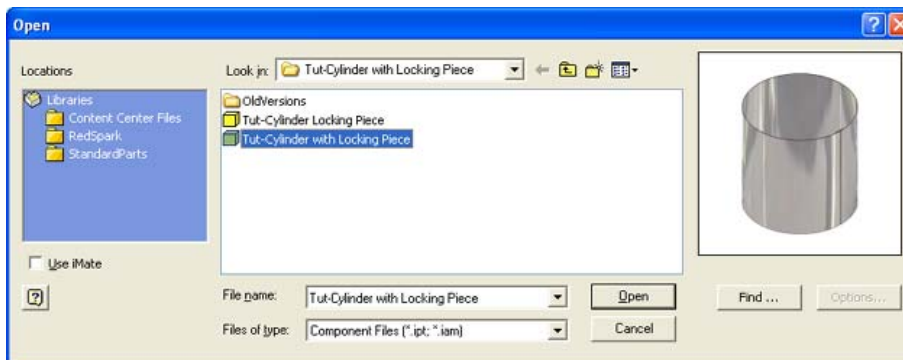

Figure 1F-7B: The Open window of the Place Component tool.

Next, select the **Place Component** tool again; the **Open** window of the **Place Component** tool opens; select the *Tut-Cylinder Locking Piece* file inside the *Tut-Cylinder with Locking Piece* folder, and click the **Open** button (Figure 1F-7D); the 3D model of the *Tut-Cylinder Locking Piece* file appears on the screen; click once to place one copy of the model; then right-click for the shortcut menu and choose the **Done** option to finish (Figure 1F-7E).

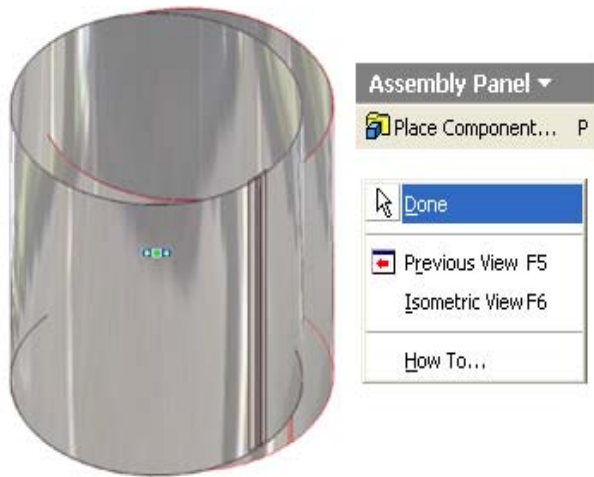

Figure 1F-7C: Placing the 3D model of the *Tut-Cylinder with Locking Piece* file.

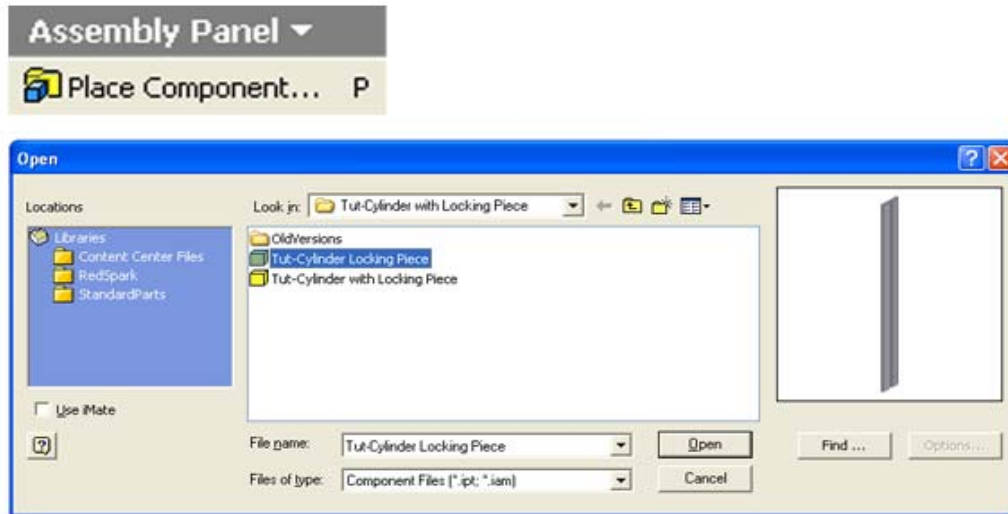

Figure 1F-7D: Selecting the *Tut-Cylinder Locking Piece* file in the **Place Component** tool's **Open** window.

Next, select the **Place Constraint** tool; in the tool's dialog window, select the **Mate** and **Flush** options (*Figure 1F-7F*); next, go to the **Model** panel, and click the + boxes on the left of the **Origin** feature, *Tut-Cylinder with Locking Piece:1* feature plus its **Origin** feature, and *Tut-Cylinder Locking Piece:1* feature plus its **Origin** feature; the **YZ Plane**, **XZ Plane**, and **XY Plane** of the three entities (the assembly file, the *Tut-Cylinder with Locking Piece:1* and the *Tut-Cylinder Locking Piece:1*) appear on the list. Next, in the **Model** panel, click-select pairs of the same **Plane** features between any pair of two entities; then click the **Apply** button in the tool's dialog window to apply the constraints after hearing a tone; the corresponding **Planes** of the entities will align; and when all pairs of **Planes** among all three entities are fully constrained (*Figure 1F-7G*), click the **Cancel** button to exit the tool.

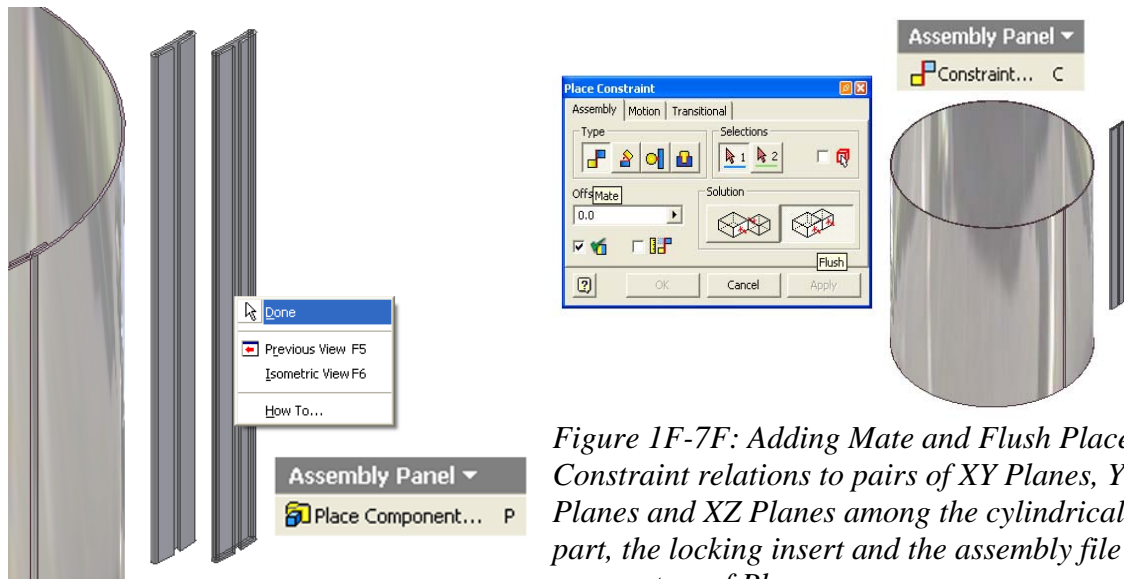

Figure 1F-7E: Placing the 3D model of the locking insert from the Tut-Cylinder Locking Piece file.

Figure 1F-7F: Adding Mate and Flush Place Constraint relations to pairs of XY Planes, YZ Planes and XZ Planes among the cylindrical part, the locking insert and the assembly file's own system of Planes.

To view the details of the locking seams of the cylindrical sheet-metal part and its corresponding separate locking insert piece, use the **Zoom Window** and **Rotate** tools (*Figure 1F-7H*). The features of the assembly are listed in the Model panel (*Figure 1F-7J*). Save and close the assembly file (*Figure 1F-7K*).



Figure 1F-7G: The parts fully assembled and constrained.

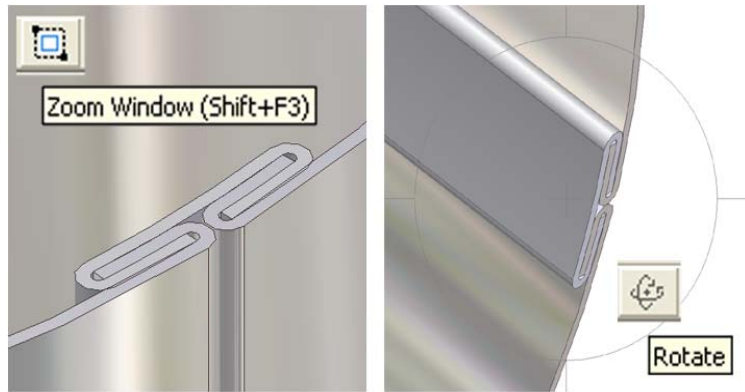

Figure 1F-7H: The locking insert and the locking seams of the cylindrical sheet-metal part.

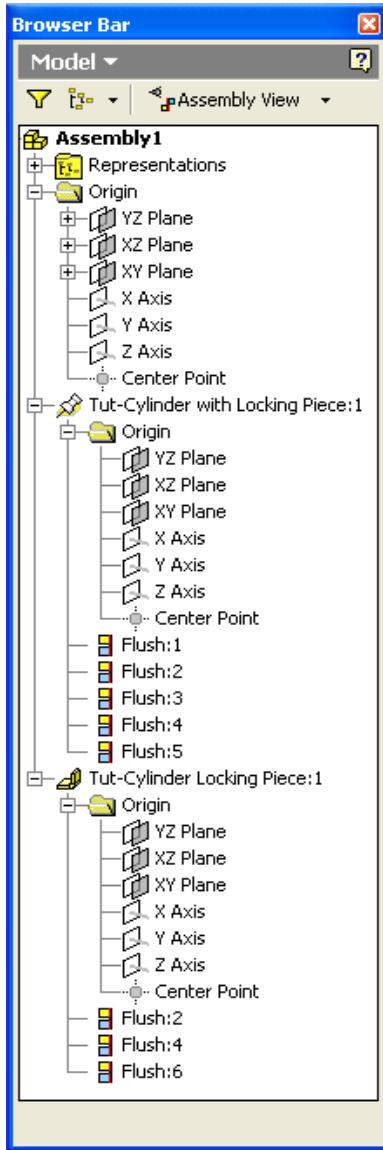

Figure 1F-7J: The features listed in the Model panel.

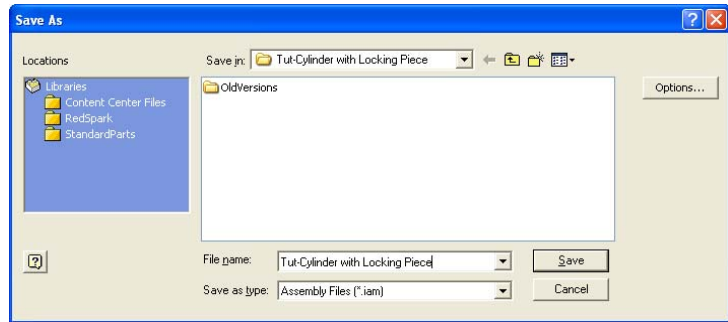

Figure 1F-7K: Saving the assembly file.

Congratulations! In this Module, you have learned how to create a cylindrical sheet-metal part with locking seams on its lateral edge, its corresponding separate locking insert, and their **Flat Pattern** views; as well as to assemble the two parts in an Inventor **Standard (in).iam** assembly file.